



ACCESSORIES [®]
for
VINEYARDS



MOLLIFICIO EFFEMME SRL

**ACCESSORI PER
VIGNETO E FRUTTETO**

WIRE TENSIONERS

Art. A1 - .. WIRE TENSIONER

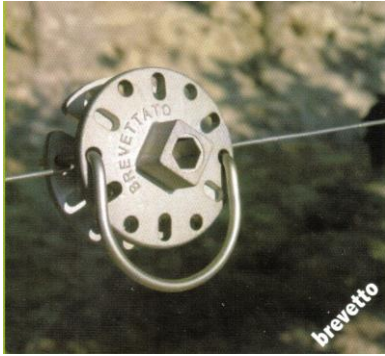

Wire Tensioner Wheel "SUNFLOWER"
MADE IN ALUMINUM DIE CASTING WITH WIRE
BLOCKAGE IN STAINLESS STEEL.

To be used for:
 STRETCHING WIRE \varnothing 3,00 mm Max

Wire Tensioner Wheel "Sunflower" + 2 stainless steel piston-pins
Wire Tensioner Wheel "Sunflower" + 1 stainless steel spring

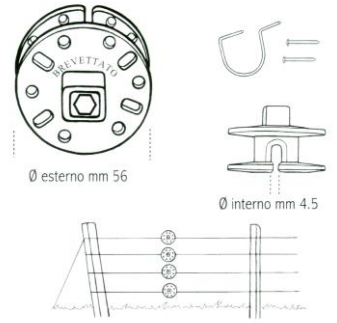

Art. A3 - .. WIRE TENSIONER



Wire Tensioner Wheel "Maxi"
MADE IN ALUMINUM DIE CASTING WITH WIRE
BLOCKAGE IN STAINLESS STEEL.

To be used for:
 STRETCHING WIRE \varnothing 6,00 mm Max

Wire Tensioner Wheel "Maxi" + 2 stainless steel piston-pins
Wire Tensioner Wheel "Maxi" + 1 stainless steel spring

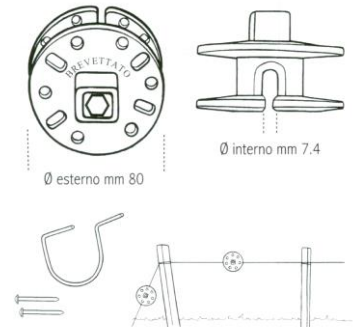

Art. A4 - .. WIRE TENSIONER

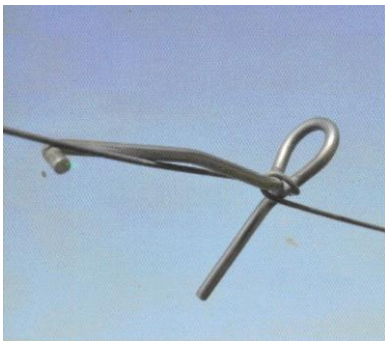

Wire Tensioner "Lino"
Made in \varnothing Wire 5,20 Zn-Al

To be used for:
 STRETCHING WIRE \varnothing 2,20 mm Max

Supplied in Boxes 250 pcs each.
 Every 1.000 pcs one kit tensioner free!
 (See article U9-04)

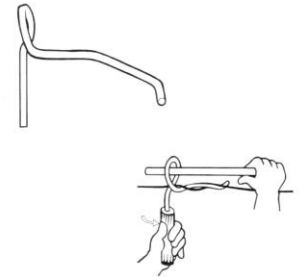

Art. A10 - .. WIRE TENSIONER



Wire Tensioner made in Metal Sheet
Made in \varnothing Wire 5,20 Zn-Al

To be used for:
 STRETCHING WIRE \varnothing 3,00 mm Max

- Available in Galvanized Metal Sheet
 - Available in Green Plastic Coated Sheet

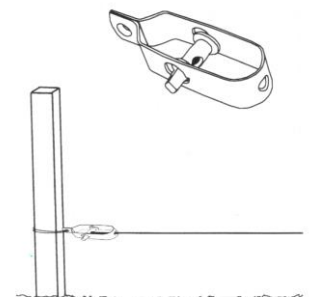

TENSIONERS

Art. A5 - .. TENSIONER COLLAR



Reinforced Collar for Concrete Post.

Used to pick up and to tension the wire by the special Roller and Hook Block-Roller.
 Available for any measures. Complete of Roller and Block Roller.

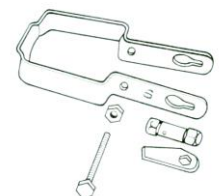

Art. A6 - .. SINGLE HOSE CLAMP



Reinforced Galvanized Hose Clamp.

This device is used to fix the chain and the tightener hook.

Provided with Roller and Hook Block-Rolled (to be used together).

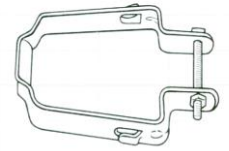

Art. A7 - 01 TIGHTENER HOOK



Reinforced Tightener Hook.

This device allows to tight the wire between the END POST and the anchor.

Provided with Roller and Hook Block-Rolled (to be used together).

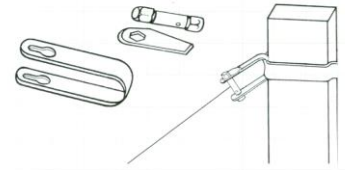

Art. A8 - 01 CHAIN ZNAL



Chain for Vineyard Posts made in ZN-AL "Crapal 4" for Wire Tensioning

Length: 20 cm

Ø Wire 2.50 mm



Art. A9 - 01 INOX CHAIN



Chain for Vineyard Posts made in Stainless Steel for Wire Tensioning

Length: 25 mt



Art. A11 - .. COLL PL

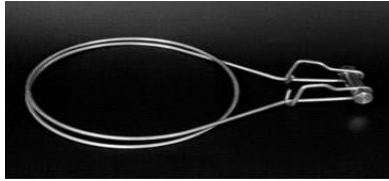

Wire Tensioner Collar for Wooden Post

Used to pick up and to tension the wire with assembled Roller and Hook Block-Roller



Art. A12 - .. COLL PC1



Wire Tensioner Collar for Concrete

Used to pick up and to tension the wire with with assembled Roller and Hook Block-Roller



Art. A13 - 01 COLL PM



Wire Tensioner Collar for Metal Post

Used to pick up and to tension the wire with the assembled Roller and Hook Block-Roller



Art. A14 - 01 TIR

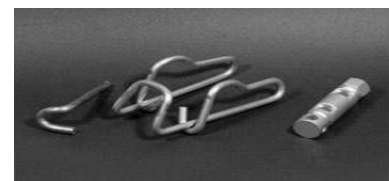

Tighter Hook.

This device allows to tight the wire between the end post and the anchor.



ACCESSORIES FOR TENSIONERS

Art. AA - .. NAILS FOR CHAIN



Zn-All/Stainless Steel Nails for Chain

Inox Version: mm 3,5 / 60
Zn-All Version: mm 4,2 / 55

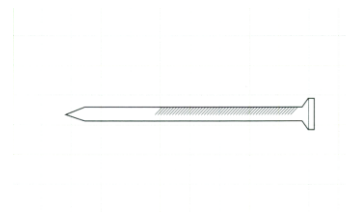

Art. AA - .. SPRINGS & SPINS

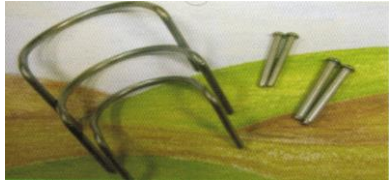

Springs/Pins for Wire Tensioner Wheel SunFlower

Springs/ Pins for Wire Tensioner Wheel Maxi

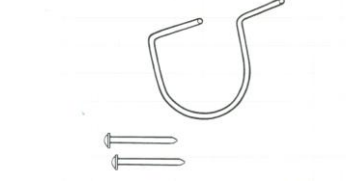

WIRE SPREADERS

Art. B5 - 01 SPRING/MS

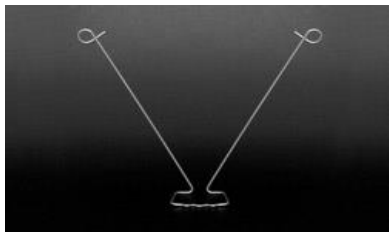

Spring for Metal poles with/without Fastened hook.

Easy to be installed, economic, once you have inserted the double wires through the eyelets, this spring can be closed directly to the slots of the Metal Post.



Art. B5 - 04 SPRING/MG

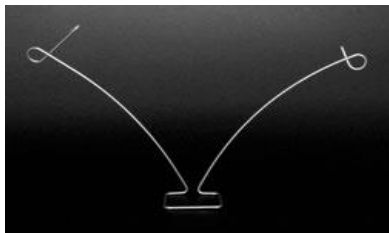

Spring for Metal Post with arched stems and Fastened hook.

Easy to be installed, once you have inserted the double wires through the eyelets, this spring can be closed thanks to its auto-closure. It can be made with / without self securing system.



Art. B5 - 05 SPRING/M2G



Spring for Metal Post with double Fastened Hook located at the two extremities.

This specific spring allows an independent vines growing. In fact, you can easily close one arm separately from the other one thanks to the double Fastened Hooks.



Art. B4 - .. SPRING/W



Spring for Wooden Post.

Easy to be mounted, economical, suitable for every kind of Wooden Post round section from Ø 80 cm to 140 cm. It can be fixed by nails / staples.



Art. B1 - .. SPRING/CS

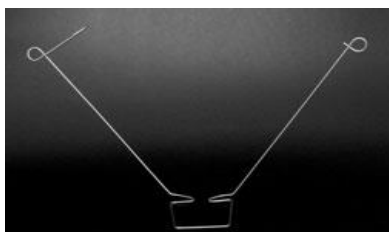

Spring with/without Fastened Hook for Concrete Post.

Think kind of economic spacer allows an efficient canopy management for concrete posts. Included our fastened hook, it does not slide down assuring an excellent gripping to the concrete post.



ACCESSORIES[®] for VINEYARDS

How can this tool be so efficient to pick up the vegetation?
How can I calculate my **ROI**? (return on investment)?
Why Should I invest money to buy a new Vineyard Device?
These are the classic questions that need an answer.
Together with its Vineyard Specialists, **Accessories for Vineyards**
has calculated all the
benefits of the springs in five years, with the following result:

5 HOURS PAR HECTAR PAR WORKER

By taking advantage of specially designed elastic mechanical accessories,
self adaptable while the vines grow, the following benefits are
achieved:

- Substantial minimization of labor forces
- Simplification of the vineyard maintenance
- Less injuries to the vines
- Better and gradual exposition of the vines to the sun

SPRING SPREADERS FOR METAL, CONCRETE & WOODEN POSTS



PHASE 1

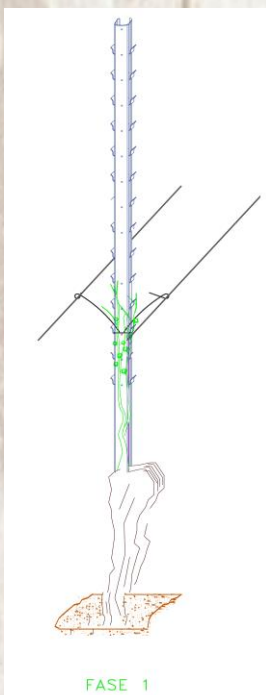

FASE 1

PHASE 2

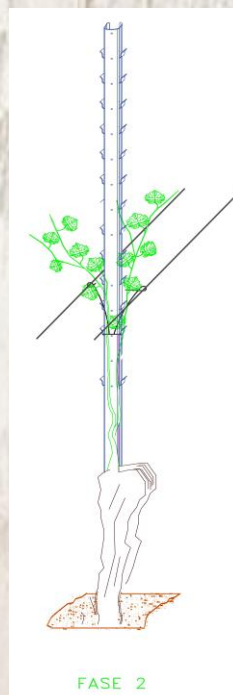

FASE 2

PHASE 3

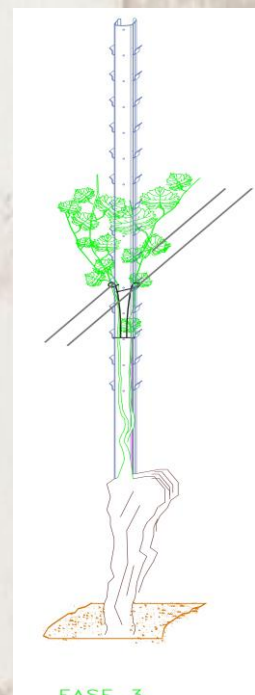

FASE 3

BRACKETS

Art. C1 - .. BRACKET/G & SS



Wire Support in Galvanized Steel.

Fixed distance between the two extremities from 160 mm to 400 mm.

Suitable for Stainless Steel and Galvanized Vineyard Wires.

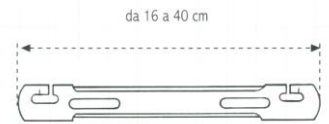

Art. C3 - .. BRACKET/AL



Wire Support in Alluminium.

Fixed distance between the two extremities of 150 cm or 23 cm

Suitable for Stainless Steel and Galvanized Vineyard Wires.

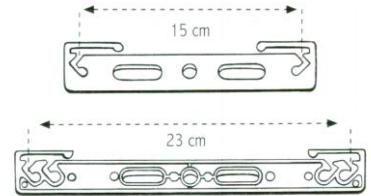

Art. C4 - .. BRACKET/W



Wire Support in Stainless Steel Aisi 302

Ø Wire 2,80 mm

For concrete post type 50- 60 – 70 – 80 - 90

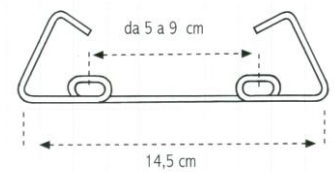

Art. C4 - .. BRACKET/COLL 1

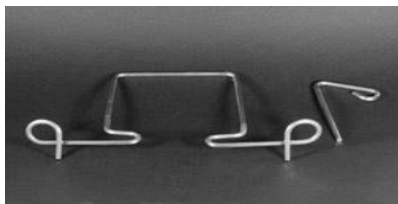

Wire Support in Stainless Steel Aisi 302

Wire Support with / without Fixing Hook (optional) for Concrete Post of any dimension. Ø Wire 2,80 mm



Art. C4 - .. BRACKET/COLL 2

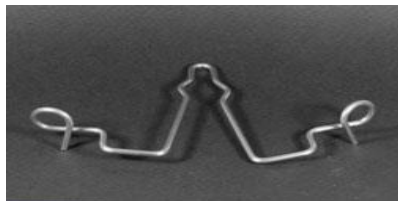

Wire Support in Stainless Steel Aisi 302

Support for Perforated Concrete Post with anti rotation system. Ø Wire 2,80 mm



Art. C4 - .. BRACKET/COLL 3

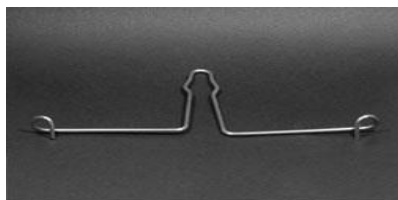

Wire Support in Stainless Steel Aisi 302

Wire Support for Perforated Concrete Post applicable to any type of pole



Art. C5 - .. BRACKET/W



Wire Support in Stainless Steel Aisi 302

Ø Wire 2,80 mm

For every kind of metal post

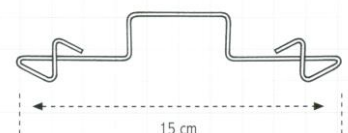

U-BOALTS

Art. D1 - .. U-BOALTS/ZN AL



U-Boalts made in Zinc-Aluminium M6 plus nuts

- U-Boalts 150/220 + 2 galvanized nuts
- U-Boalts 230/280 + 2 galvanized nuts
- U-Boalts 300 + 2 galvanized nuts
- U-Boalts 150/220 + 2 Stainless Steel nuts
- U-Boalts 230/280 + 2 galvanized nuts
- U-boalts 300 + 2 Stainless Steel Nuts

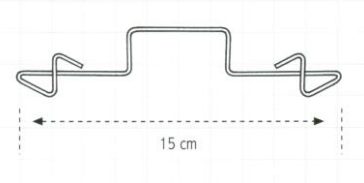

Art. D3 - .. WASHER



Washer for U-boalts

Galvanized or Inox Ø 6 / 18

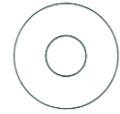

CLAMPS FOR END VINEYARD POST

Art. E1 - .. ALUMINIUM CLAMP



Clamp for End Vineyard Post (Alluminium)

Made in Alluminium Alloy 8 x 6 & 9 x 7

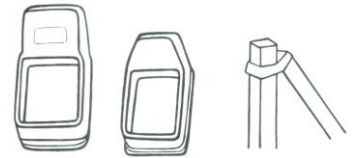

Art. A6 - .. GALVANIZED STRIP

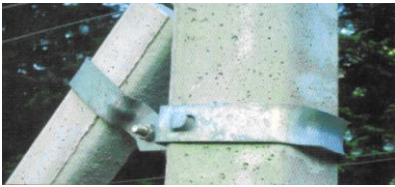

Galvanized Clamp for End Vineyard Post

- Single Clamp 5x5/6x6
- Single Clamp 7x7
- Single Clamp 7x8
- Single Clamp 8x8
- Single Clamp 9x9
- Single Clamp 8x12

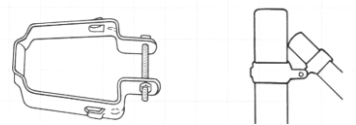

Art. E3 - .. HDG CLAMP



Hot Galvanized Clamp for Wooden Post

Used to brace the longitudinal End Vineyard Post.
Complete of U-boalts and Stainless Steel Nuts
U-boalts Ø mm 8 bend from 7,5 cm to 15 cm

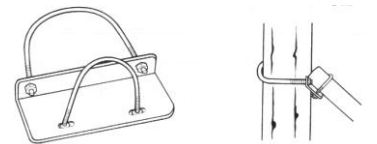

Art. E4 - 01 PLATFORM



Platform made in Concrete

Used to brace the End Vineyard Post.
Dimension: 16 x 16 x 8

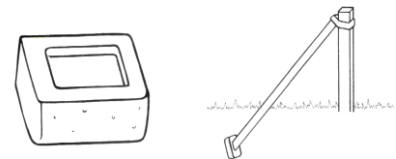

ANCHORANGE

Art. F1 - .. ANCHORS

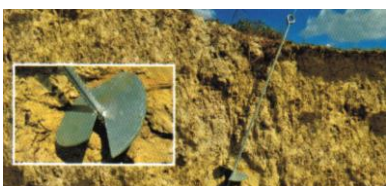

Galvanized Coil Anchor hot Galvanized

- Coil Ø mm 140 – Support Ø 12/14 – H cm 80
- Coil Ø mm 140 – Support Ø 12/14 – H cm 100
- Coil Ø mm 180 – Support Ø 14/16 – H cm 100
- Coil Ø mm 180 – Support Ø 14/16 – H cm 100

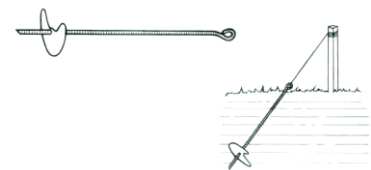

Art. F2 - .. ANCHORING PLATE



Anchoring Plate

Thickness: 8 cm
Square Plate cm 31 x 31 – Round Plate Ø cm 30 / Ø cm 40

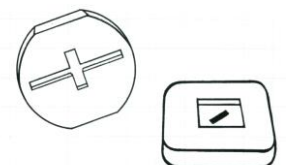

Art. F3 - .. GALVANIZED SHAFT



Galvanized Shaft

Diameter 12 Length 1,00 m – 1,20 m – 1,50 m
Diameter 14 Length 1,20 m – 1,50
Locking Device Ø 14 – Length 23 cm

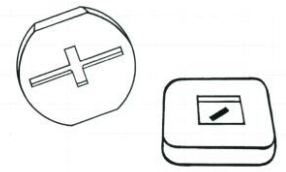

Art. F4 - .. ANCHORAGE PICKET



Anchorage Picket

Anchorage made in Alluminium Alloy complete of Galvanized Chain



CONNECTORS FOR WIRES

Art. G1- .. PVC CONNECTOR



Pvc Connector with anti UV

Pvc Connector Ø mm 1,20/1,60 Drahtduo S
Pvc Connector Ø mm 1,80/2,20 Drahtex O S
Pvc Connector Ø 2,50/3,10 Drahtex I S

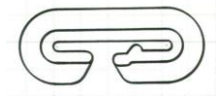

Art. G2 - 01 BIO CONNECTOR

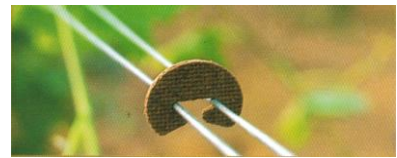

Biodegradable Connector For Vineyards wires

Made in Wood Fiber, suitable for biological agriculture

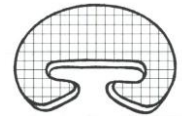

Art. G3 - 01 ALU CONNECTOR



Alluminium Connector for Wires

Made in Alluminium alloy.



PVC PLATES

Art. H1 - 01 PVC PLATE DRAHT

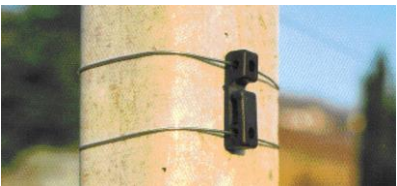

Pvc Plate for Wooden/Concrete Post



Art. H3 - 01 INOX PLATE



Inox Plate for Wooden/Concrete Post



Art. H4 - 01 PVC PLATE "N"



Pvc Plate for Wooden/Concrete/ Metal Post



HOOKS FOR STAKES

Art. L1 - .. HOOK FOR STAKE

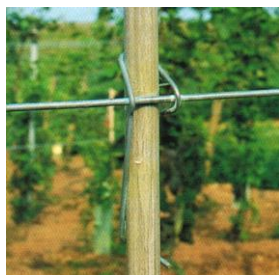

Hook for Stake made in Zinc-Alluminium/Stainless Steel

Available from Ø 6 mm to Ø 24 mm



Art. L2 - .. HOOK GALVANIZED

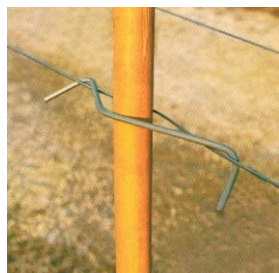

Hook for Stake made in Zinc-Alluminium/Stainless Steel

Available from Ø 6 mm to Ø 24 mm



Art. L3 - 01 HOOK INOX MINI

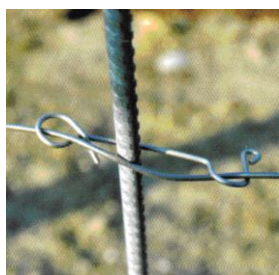

Hook for Stake Mini made in Stainless Steel

Available from Ø 7 mm to Ø 12 mm

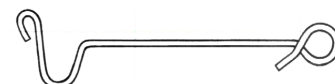

Art. L4 - 01 HOOK INOX MAXI

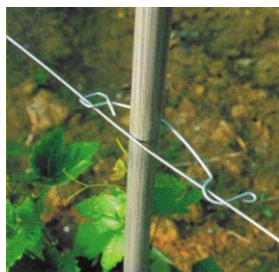

Hook for Stake Maxi made in Stainless Steel

Available from Ø 14 mm to Ø 24 mm

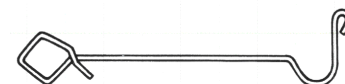

Art. L5 - .. UNFASTEN HOOK



Unfasten Hook

Available from Ø 14 mm to Ø 24 mm.

Made in Galvanized Ø wire 2,50 mm.

Made in Stainless Steel Ø wire 2,00 mm

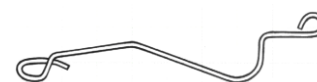

Art. L6 - .. WIRE BLOCKAGE



Wire Blockage in Stainless Steel

Wire Blocakge 65 Ø 7/8 mm

Wire Blocakge 75 Ø mm 10/12

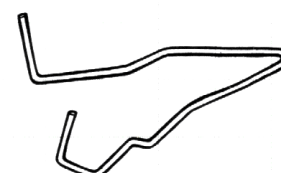

Art. L7 - 01 UNFASTEN W HOOK



Unfasten Hook for Wooden Post

Made in Galvanized Wire \varnothing 2,50 mm.
Suitable for Wooden Posts \varnothing 35 mm max.



Art. L8 - .. BLOCKING WIRE



Hook Blocking Wire for Concrete Post

Made in Galvanized Wire \varnothing 2,50 mm / \varnothing 3,00 mm

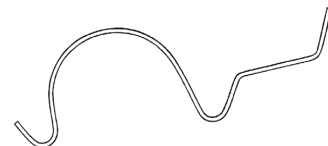

Art. L9 - .. HOOK FOR PLANT

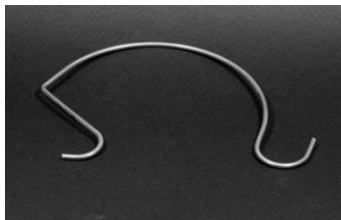

Hook for plants

Made in Galvanized / Stainless Steel Wire
Available types: 50/70/120



STAPLES

Art. M1 - .. HARPOONED STAPLE



Harpooned Staple made in Zinc-Alluminium

Harpooned Staple mm 3,0/30
Harpooned Staple mm 3,5/35
Harpooned Staple mm 4,0/50



Art. M2 - .. SMOOTH STAPLE



Smooth Staple made in Zinc-Alluminium

Smooth Staple mm 3,1/31
Smooth Staple mm 3,4/34
Smooth Staple mm 3,8/38



Art. M4 – 01 FENOX STAPLE



Fenox Staple

Harpooned Staple made in Galvanized Steel



NAILS

Art. N1 – .. CRAPAL NAIL



Nail Spreader

Made in Zinc-Alluminium
Available the following measures:
3,4 x 40 mm / 3,4 x 55 mm / 3,4 x 60 mm / 3,4 x 65 mm

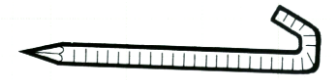

Art. N3 – 01 FENOX NAIL



Nail

Made in Galvanized Steel

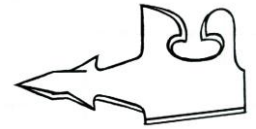

Art. AA – .. NAIL FOR CHAIN



Stainless Steel / Crapal Nail for Chain

Stainless Steel Nail for chain mm 3,5/60
Crapal Nail for chain mm 4,2/55



OTHERS

Art. 01 – .. PVC TUBING



Pvc Tubing

Available: Standard & SL (high quality).
Balls 1 kgs. Coil 4/5 kgs. Ø 1 – 2 – 3 – 4 – 5 – 6



Art. 02 – .. ELASTIC BANDEX



Tie Bandex

Bandex Ø mm 50 x 5
Bandex Ø mm 70 x 5
Bandex Ø mm 80 x 5
Bandex Ø mm 100 x 5

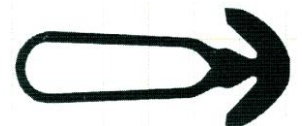

Art. 03 – .. ELASTIC STRIP



Elastic Pvc Strip with Adjustable Locking

Elastic pvc lego mm 190
Elastic pvc lego mm 260
Elastic pvc lego mm 390



Art. 03 – 04 STRIP GUYOT



Adjustable Elastic Pvc Strip for Vine Shoots

Elastic Pvc Strip LEGO mm 120

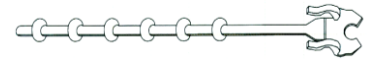

Art. 04 – 01 JOINER

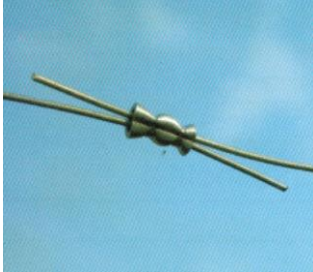

Wire Joiner Suitable for Vineyard Wires

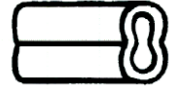

Art. 04 – .. WIRE JOINER

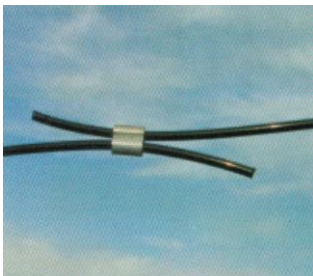

Wire Joiner for PVC wires

- Alluminium Joiner Ø 2,50
- Alluminium Joiner Ø 3,00
- Alluminium Joiner Ø 4,00
- Alluminium Joiner Ø 5,00
- Alluminium Joiner Ø 6,00



Art. 05 – .. GRIPPLE



Wire Joiner Gripper Plus

Alluminium Joiner Ø 2,50, Ø 3,00, Ø 4,00, Ø 5,00, Ø 6,00



Art. 06 – 01 SHELTER POLIBOX



Covering for Plant Shelter Polibox

Available: cm 40 / 50 cm / 60 cm



Art. 09 – 02 GPACK



G Pack Gripper

To tension the wire between the anchor and the vineyard end post.



Art. 10 – 01 NEEDLE AG

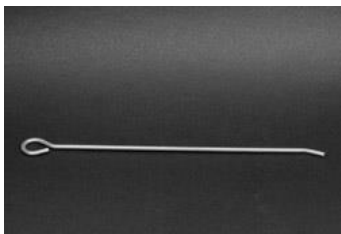

Blocking Net Needle

For Vineyards and Orchards. Ø Wire 2,50 mm Galvanized.



Art. 11 – 01 CAM

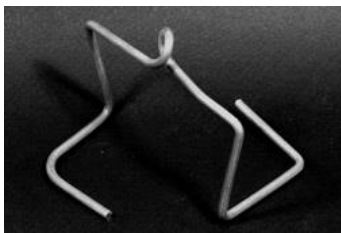

Staple for any type of Concrete Pole



STAKES AND SUPPORTS

Art. S1 - .. STEEL STAKE



Steel Stake for Vineyards

Available raw steel and hot galvanized.

Ø 7 raw available H mm 1000 / 1200

Ø 8 raw available H mm 1000 / 1200 / 1500

Ø 10 raw available H mm 1200

Ø 7 & Ø 8 Hot Galvanized available H mm 1200



Ø 7 mm



Ø 8 mm



Ø 10 mm

Art. S2 - .. BAGUETTE



Steel Stake in Zinc- Aluminium

Ø 7 available H mm 1000

Ø 7 available H mm 1200

Ø 7 available H mm 1500 – Net Weight gr 300 / ml

Ø 8 available H mm 1200 – Net Weight gr 390 / ml



Ø 7 mm



Ø 8 mm

Art. S3 - .. PVC STAKE



Pvc Stake for Vineyard

Round Stake made in Pvc Ø 21, Ø 24

Octagonal Stake made in Pvc Ø 24

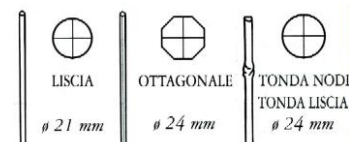

Art. S4 - .. BAMBOO STAKE



Bamboo Stake

Made in Natural Bamboo Ø 10/12 – Ø 18/20 – Ø 20/22 – Ø 22/24 – Ø 24/26.

H ML 1,05 – 1,20 – 1,50 – 2,10 – 2,40



diametri vari

Art. R2 - .. PINE STAKE



Treated Pine Stake

Different Heights available: 1,50 – 2,00 – 2,20 – 2,40

Uncortex and Sharpened

Ø 2,5/4 – Ø 3,5/5,5-4/5 – Ø 5,5/7,5



Art. U1 - .. RING KNIFE

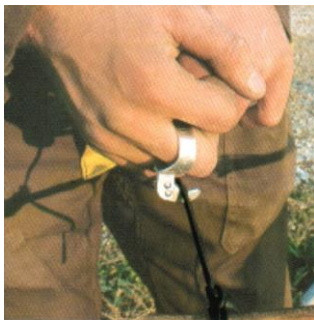

Ring Knife.

Suitable to cut Pvc tubing.

Ø Ring mm 22

Ø Ring mm 24



Art. U2 - 01 LAYING NEEDLE



Laying Needle for RootStock.

Needle in Stainless Steel



Art. U3 - 01 UNROLLER

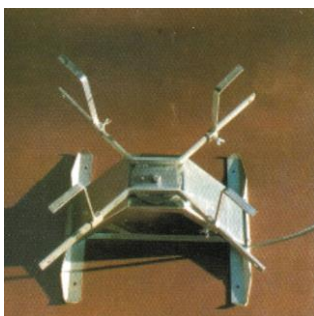

Unroller for Vineyards Wires.

Made in Hot Galvanized.

Different models available.

Art. U6 - 01 TORQ TOOL



Torq Tool.

Used to tension vineyards wire or fencing systems



Art. U7 - 01 POST DRIVER



Hand Pile Driver

Used to install manually metal posts.

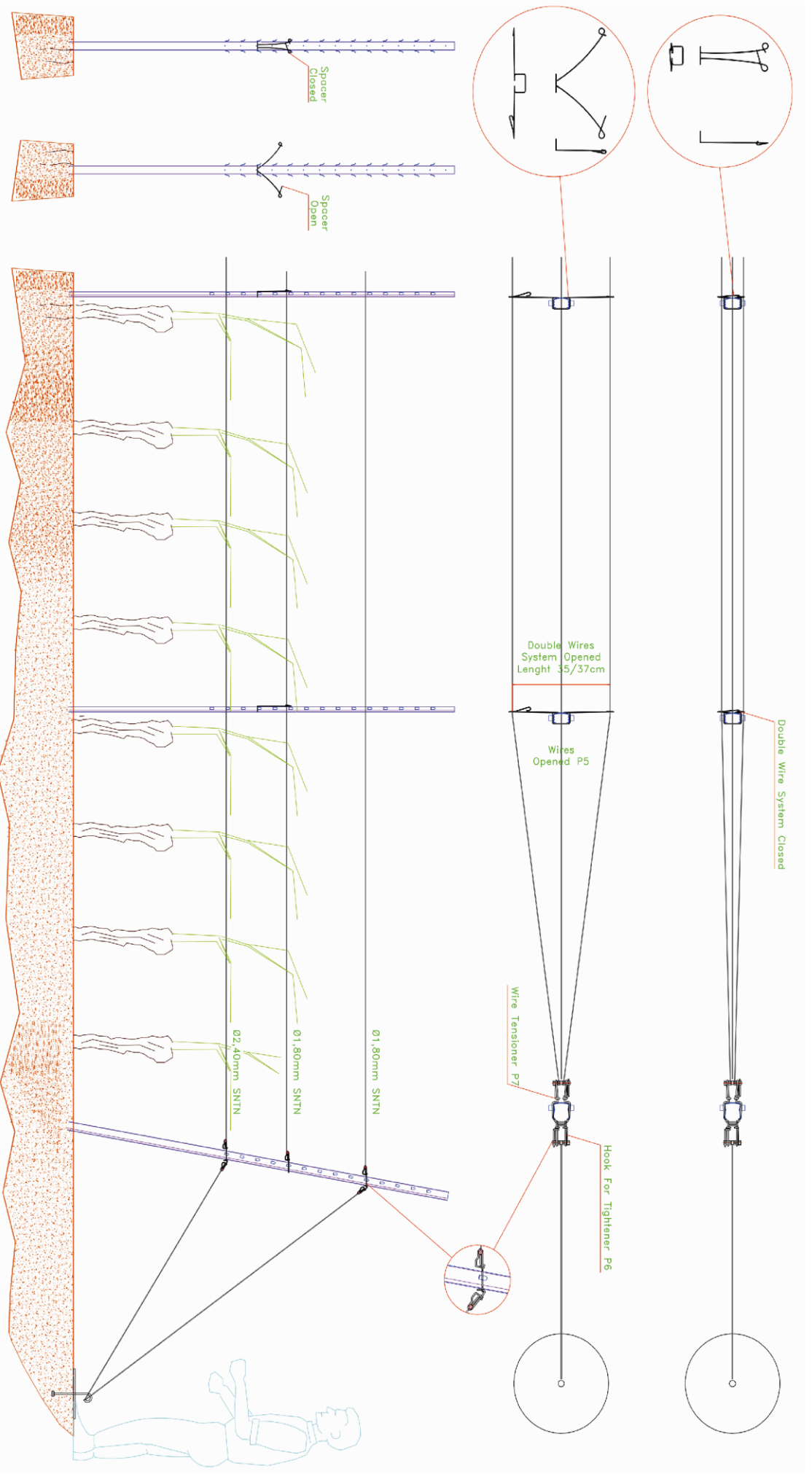

VINEYARD PARAMETERS FOR 1 HECTAR

Material

- Metal End Post
- Intermediate Metal Post
- Vineyard Wire for Anchor 3,00 mm
- Main Vineyard Wire SNTN 2,20 mm
- Containing Vineyard Wire SNTN 1,80 mm
- Wire Tensioner Collar for End Post
- Hook For Tightener
- Anchors
- Wire Tensioner Wheel
- Galvanized Stakes
- Hook for Stake
- Spring for Metal Post

Measures

- Row Distance: 2,50 Mt
- Post Distance: 4,50 Mt
- Length: 220 Mt
- Length: 3900 Mt
- Length: 23400 Mt
- 2 par End Post
- 1 par Anchor
- 2 par Row
- 5 each Row
- Stake Distance: 1 Mt
- Stake Distance: 1 Mt
- Two par Post

Qty par Ha

- 110
- 890
- 12
- 119
- 468
- 220
- 110
- 110
- 550
- 4000
- 4000
- 1780

Material Installation

- Installation End Post
- Installation Intermediate Post
- Installation Wire
- Installation Wire
- Installation Wire
- Spring Installation
- Spring Installation
- Installation and Anchor Tightening
- Installation Tensioner
- Installation Stake
- Installation Stake
- Spring Installation



**Registered
Trademark by**



**Strada dell'Antica Fornace 9
14053 CANELLI (AT) - ITALY
Tel: +39-0141-822524 / Fax: +39-0141-290000**

www.accessoriesforvineyards.com

Commerciale Italia: italia@accessoripervigneto.com

Commerciale Estero: export@accessoriesforvineyards.com



Follow us on Facebook!

Material and Accessories for Vineyards and Orchard

CANELLI (AT)



**Experience in the Viticulture since 20 years.
Thanks to our collaboration with the best Producers
we are able to supply a full service to the winegrower.
We can advise a complete framework for your Vineyards!**